

MARCH 2010

ELECTRIC CHAIN HOIST PART LIST

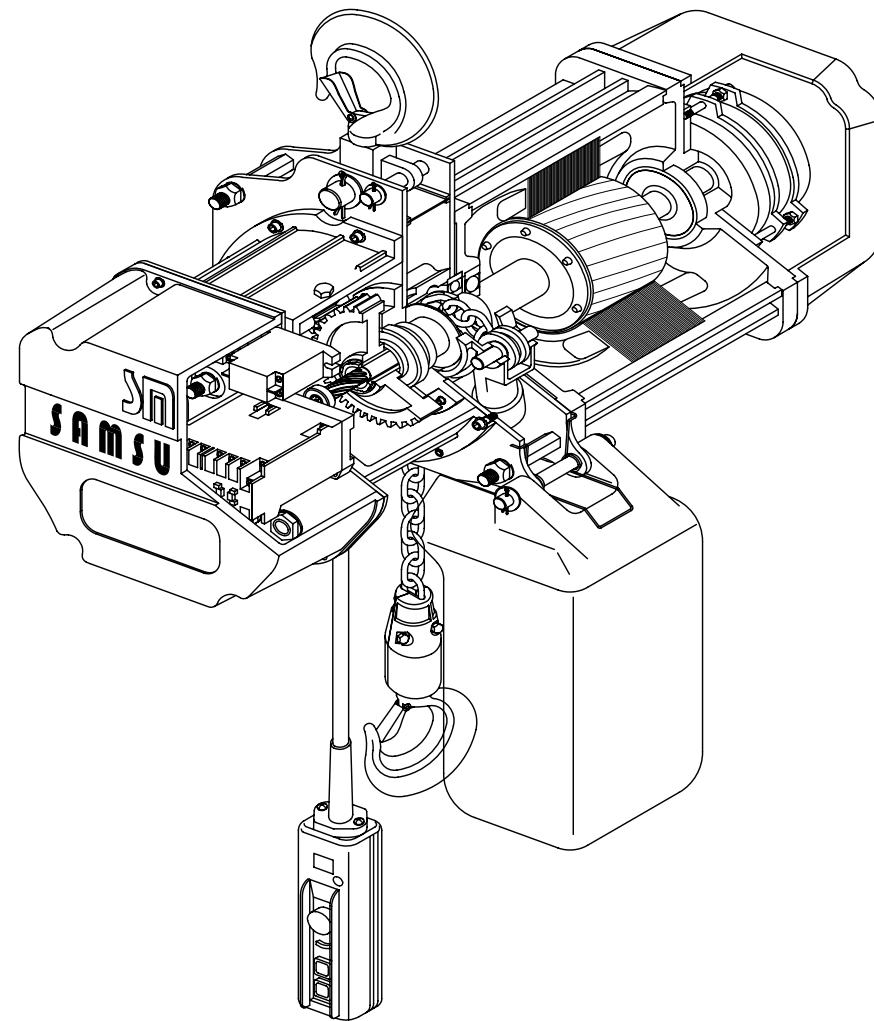

SM SAMSUNG MACHINERY CO., LTD.

Exploded View of Chain hoist Parts A-FRAME (0.25, 0.5 Ton)

GBS: GEAR BOX
 THS: TOP HOOK
 BKS: BRAKE
 MOS: MOTOR
 CFS: CENTER FRAME
 BHS: BOTTOM HOOK

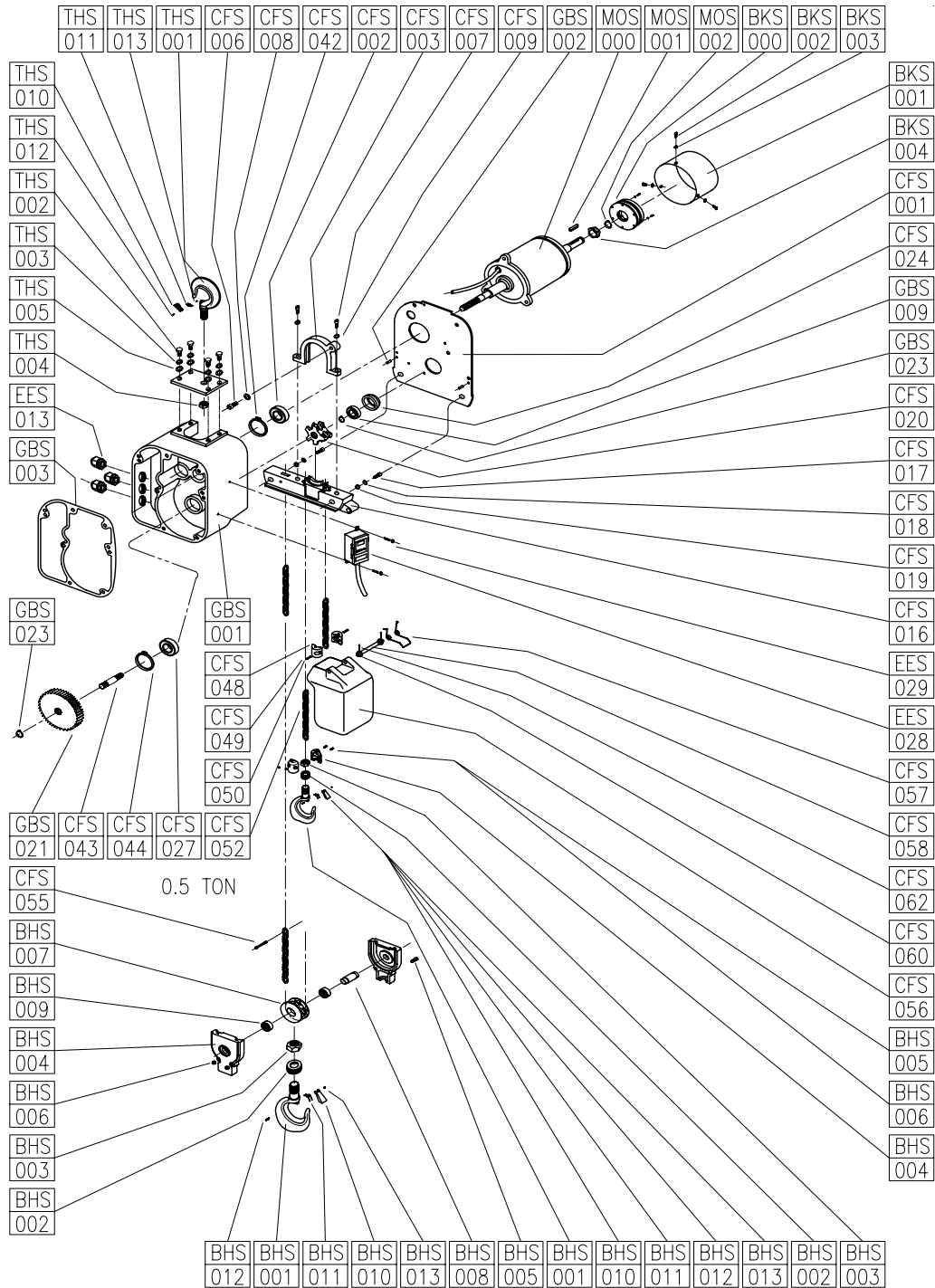
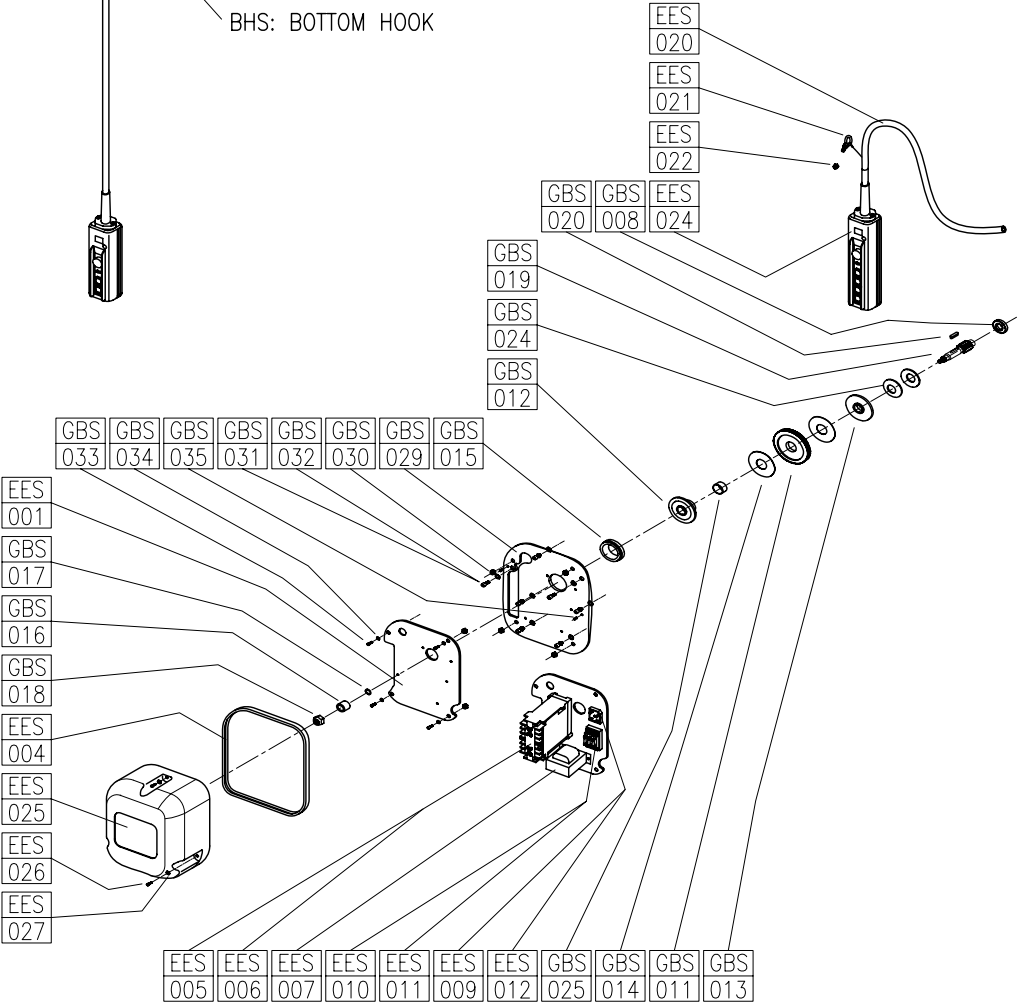

Exploded View of Chain hoist Parts B-FRAME (1, 3(2Falls) Ton)

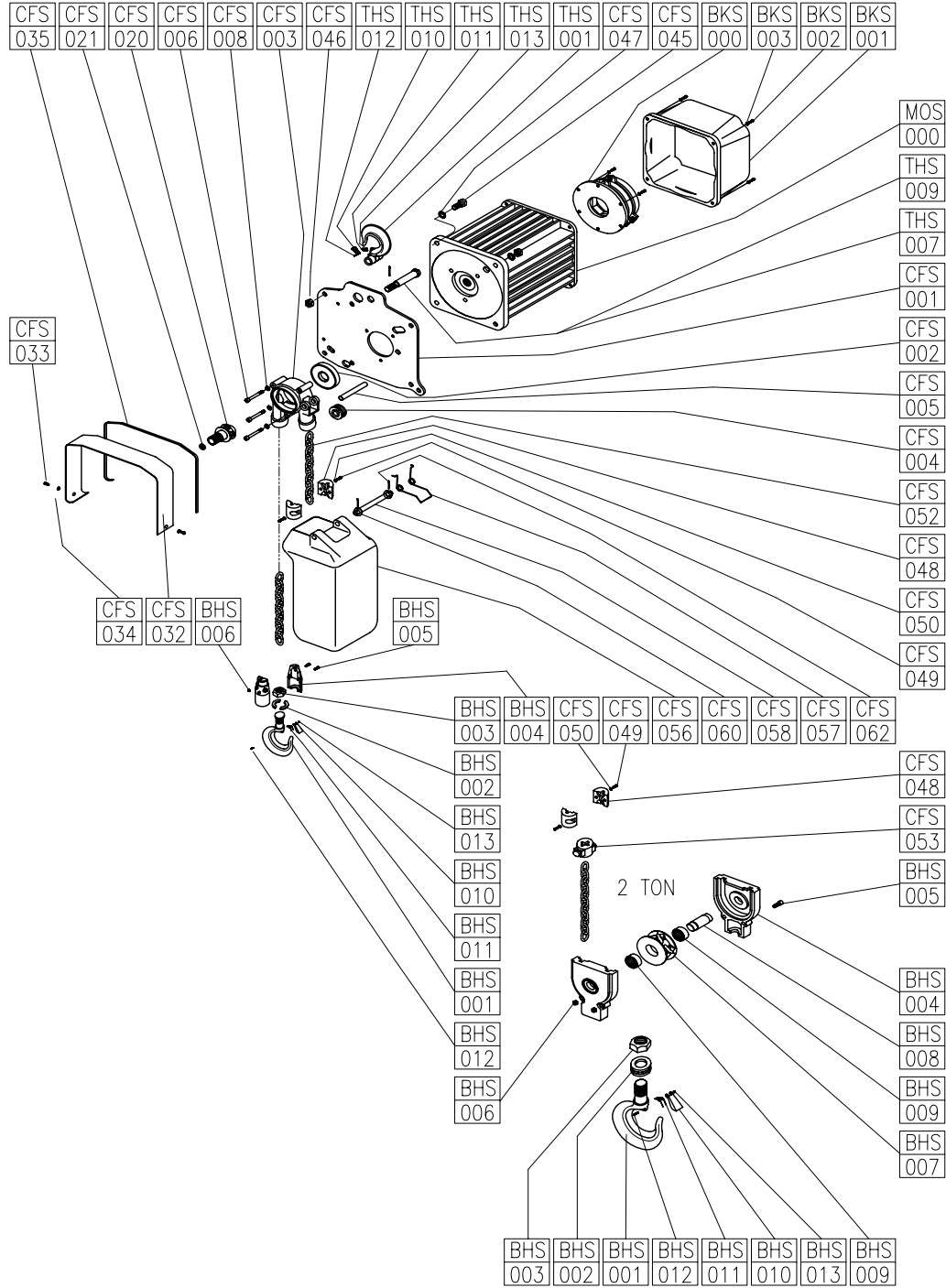
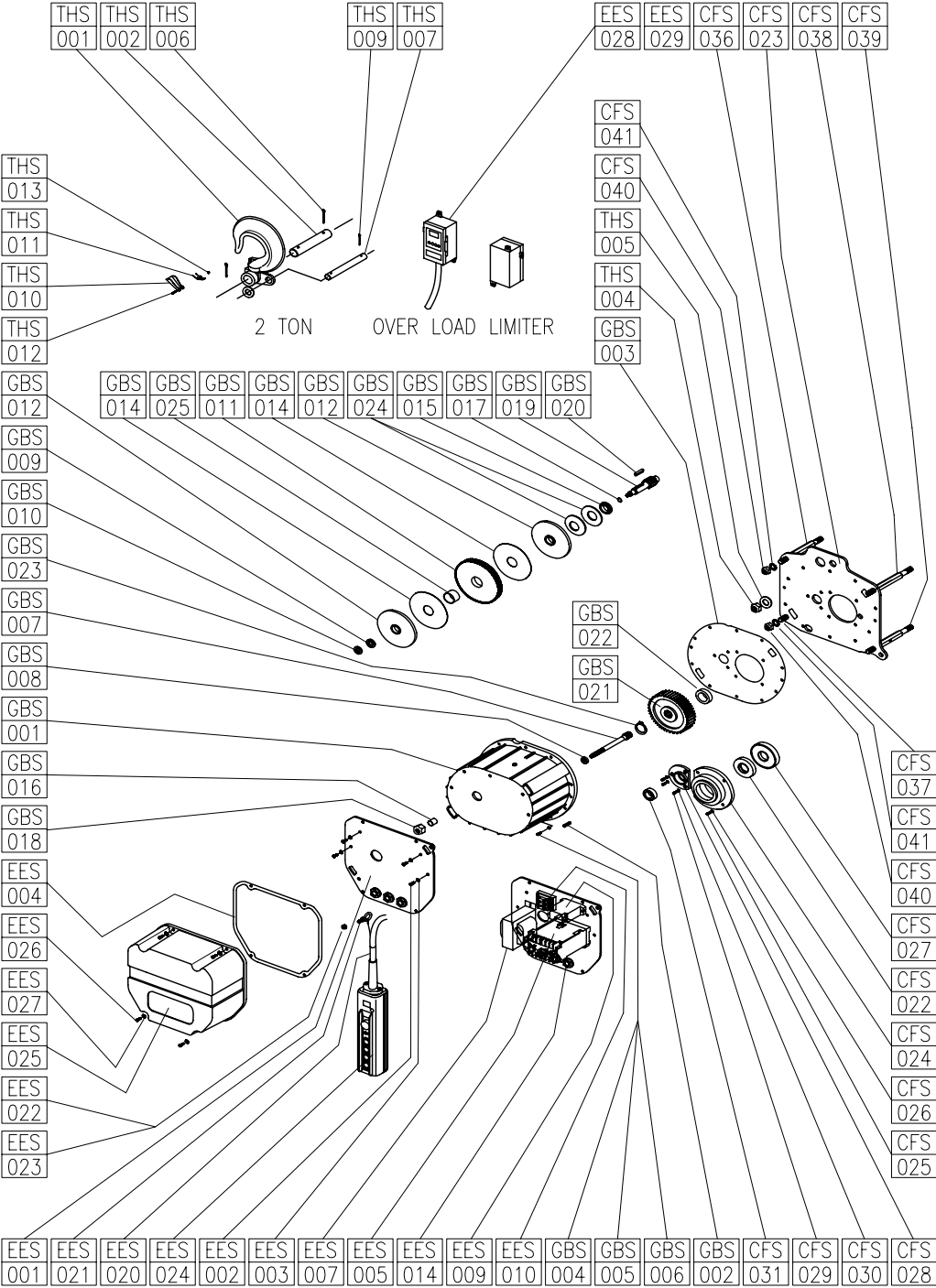

Exploded View of Chain hoist Parts C-FRAME (3, 5 Ton)

GBS: GEAR BOX
 THS: TOP HOOK
 BKS: BRAKE
 MOS: MOTOR
 CFS: CENTER FRAME

BHS: BOTTOM HOOK

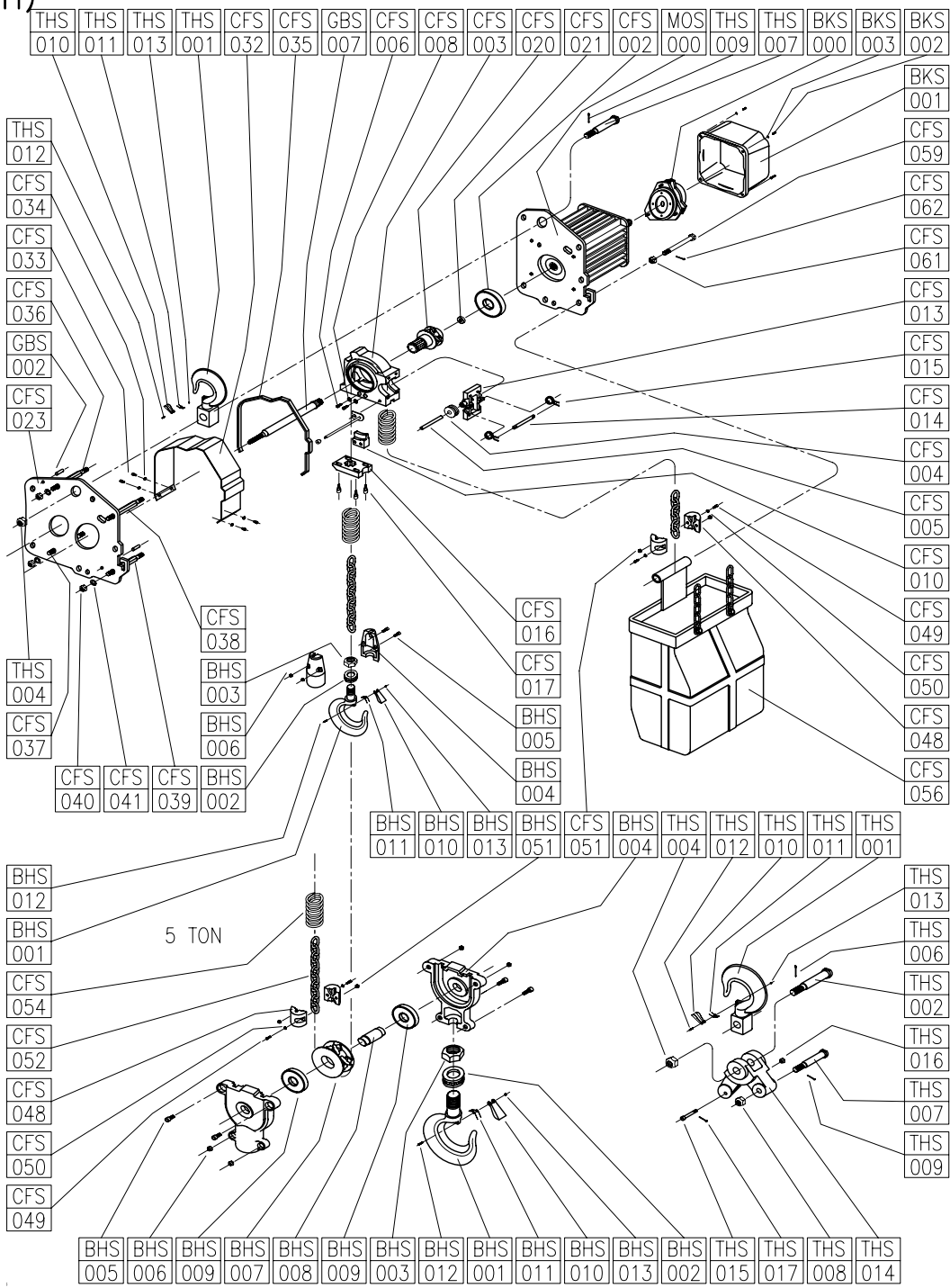
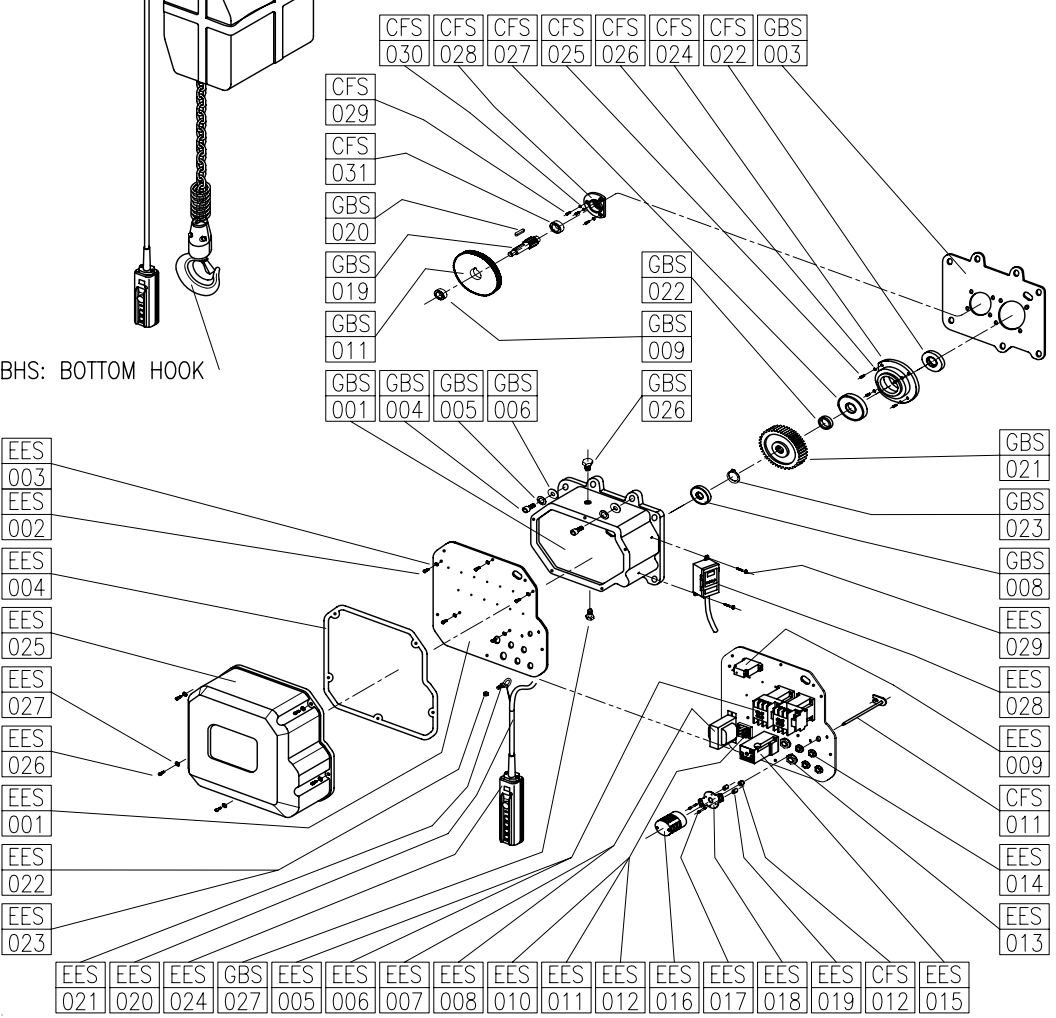

Exploded View of Motor Trolley Parts

